

OPERATING INSTRUCTIONS



TYPE **1210-C**

UNIT R-C OSCILLATOR

GENERAL RADIO COMPANY

OPERATING INSTRUCTIONS

TYPE **1210-C**

UNIT R-C OSCILLATOR

Form 1210-0100-H

August, 1964

G E N E R A L R A D I O C O M P A N Y

WEST CONCORD, MASSACHUSETTS, USA

SPECIFICATIONS

311 at
115 v

Frequency

Range: 20-500,000 cps in five ranges: 20-200, 200-2000, 2000-20,000, 20,000-200,000, and 50,000-500,000 cps.

Controls: Range selection switch and 4-inch precision gear-driven dial. Dial has two scales, 2-20 and 50-500, and is geared to a slow-motion knob that covers each decade in about $4\frac{1}{2}$ turns.

Accuracy: $\pm 3\%$.

Stability: Warm-up drift is less than 1%, essentially complete in 1 to 2 hours.

Output

Control: Logarithmic, calibrated 0-50 db.

Low-Impedance: (for loads of 500 ohms and higher) 0-7 v, open circuit, constant within ± 1 db up to 200 kc; internal output impedance 50 ohms at full output, 1250 ohms at half output; no-load distortion less than 1% from 200 cps to 10 kc, less than 1.5% over entire frequency range. Attenuator calibration is reliable for loads of 12,000 ohms and above. Hum is at least 60 db below output voltage level.

High-Impedance: (for loads of 10,000 ohms and higher) 0-45 v, open circuit, constant within ± 1 db from 200 cps to 150 kc; distortion less than 5% from 200 cps to 200 kc, no load (reduced under load). Internal output impedance 14,000 ohms regardless of attenuator setting. Hum at least 50 db below maximum output voltage level.

Square Wave: 0-30 v peak-to-peak, open circuit; rise time approximately $\frac{1}{2}$ μ sec, (decreases to about 0.15 μ sec with load of 1000 ohms); overshoot approximately 1%; hum at least 60 db below output voltage level; internal output impedance 2500 ohms.

Tube Complement: One each 6BQ7-A, 0B2, 6189/12AU7-WA, 12AU7.

Terminals: Two jack-top TYPE 938 binding posts, one grounded to panel.

Power Input: 6.3 v ac or dc at 1 amp; 300 v dc at 60 ma.

Power Supply Recommended: TYPE 1203-B Unit Power Supply for operation from 115 v, 50-60 cps.

The TYPE 1201-B Unit Regulated Power Supply will provide a slight improvement in frequency stability on the highest frequency range.

Instrument will operate satisfactorily on power-supply frequencies up to 400 cps, with either power supply.

Accessories Available: For higher output (3 watts) use TYPE 1206-B Unit Amplifier; for graphic recording, TYPE 907-R144 Dial Drive.

Mounting: Gray finish; aluminum panel and chassis; bench mounting. The TYPE 480-P4U3 Relay Rack Adaptor Panel is available for use with oscillator and power supply combination. Panel height, 7 inches.

Dimensions: (Oscillator and Power Supply, as shown) width 15, height $5\frac{3}{4}$, depth 7 inches (380 by 145 by 175 mm) over-all.

Net Weight: $5\frac{1}{2}$ pounds (2.5 kg).

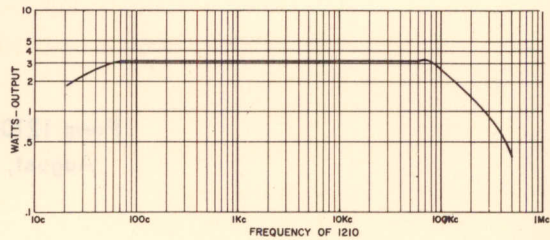

Output of the Type 1210-C Unit Oscillator with Type 1206-B Unit Amplifier, into 600-ohm load.

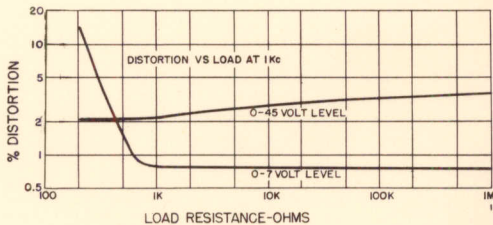
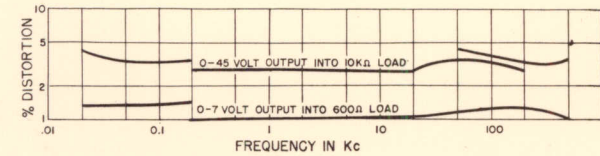
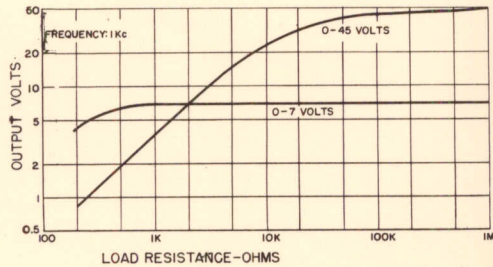
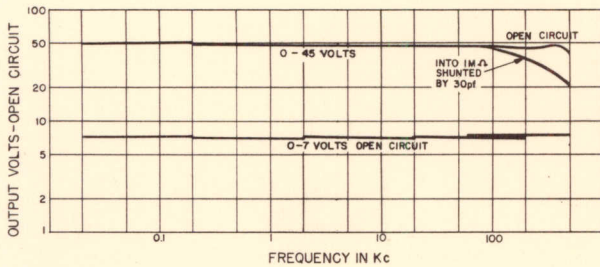

Typical output and harmonic distortion characteristics of the Type 1210-C Unit RC Oscillator as functions of frequency and load.

TABLE OF CONTENTS

Section 1. INTRODUCTION	1
1.1 Purpose	1
1.2 Description	1
Section 2. PRINCIPLES OF OPERATION.	3
2.1 Oscillator Circuit	3
2.2 Automatic Gain Control Circuit	3
2.3 Output Amplifier	3
Section 3. INSTALLATION	4
3.1 Power Supply	4
3.2 Other Accessory Equipment	5
Section 4. OPERATING PROCEDURE	6
4.1 Frequency Setting	6
4.2 Output Systems	6
Section 5. SERVICE AND MAINTENANCE	7
5.1 Warranty	7
5.2 Service	7
5.3 Input Power	9
5.4 Removal of Cover	9
5.5 Tube Replacement and Adjustments	9
5.6 Tube Voltage and Resistance Measurements	9
PARTS LIST	12

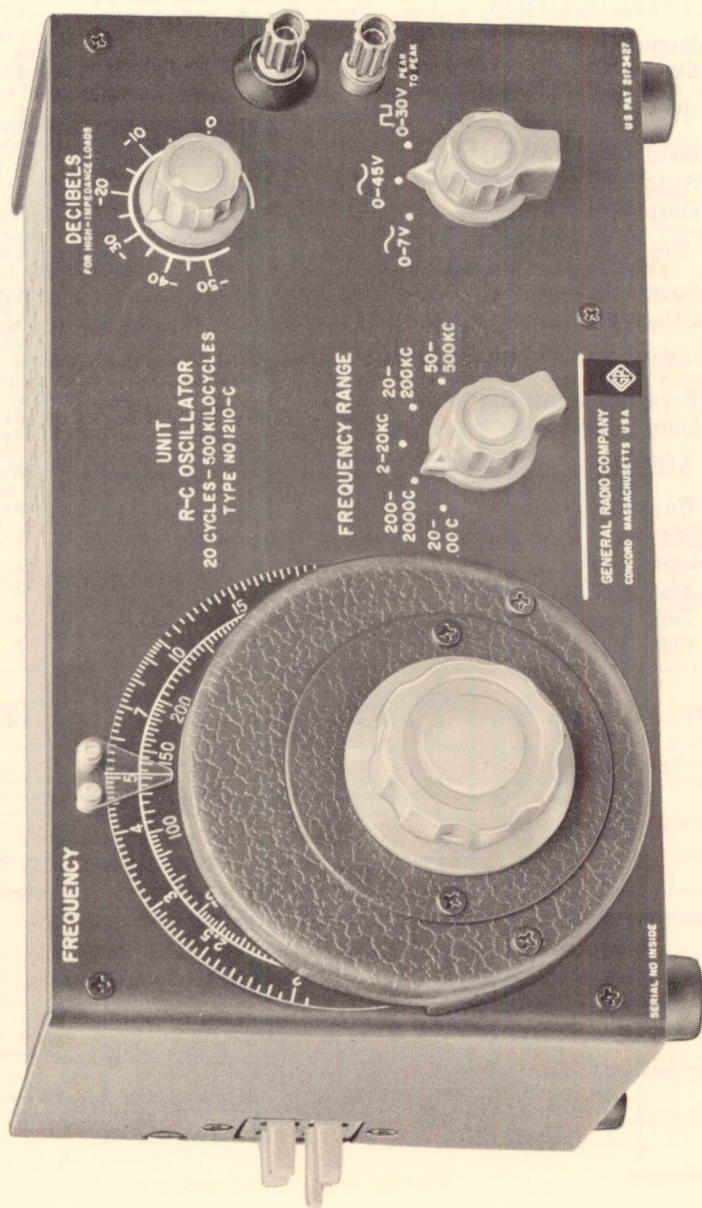

Figure 1. Type 1210-C Unit Oscillator.

1.1
ca
ty
the
tes
sw
ca
sc

1.2
1.2
121

Na
FR
DE
SIM
WA

No
1.2
Ty
Co
Mu
Jac

TYPE 1210-C

UNIT R-C OSCILLATOR

Section 1

INTRODUCTION

1.1 PURPOSE. The Type 1210-C Unit R-C Oscillator (Figure 1) is a capacitance-tuned oscillator that combines the standard features of this type of instrument with square-wave output and "sweepability." With the square-wave output, both low- and high-frequency square-wave tests of transient behavior are possible. Since the instrument can be swept mechanically (refer to paragraph 3.2.1), frequency characteristics can be recorded either on level recorders or on cathode-ray oscilloscopes.

1.2 DESCRIPTION.

1.2.1 CONTROLS. The following controls are on the panel of the Type 1210-C Unit R-C Oscillator:

<u>Name</u>	<u>Description</u>	<u>Use</u>
FREQUENCY RANGE	5-position rotary switch	Selects frequency range.
DECIBELS	Rotary knob	Varies output level.
SINE WAVES - SQUARE WAVES	3-position rotary switch	Selects sine-wave low-impedance, sine-wave high-impedance, or square-wave output.
None	4-inch circular dial	Selects frequency.

1.2.2 CONNECTIONS. The following table lists the connections on the Type 1210-C Unit R-C Oscillator.

<u>Connection</u>	<u>Use</u>
Multipoint connector	Power supply connection
Jack-top binding posts (2)	Output terminals

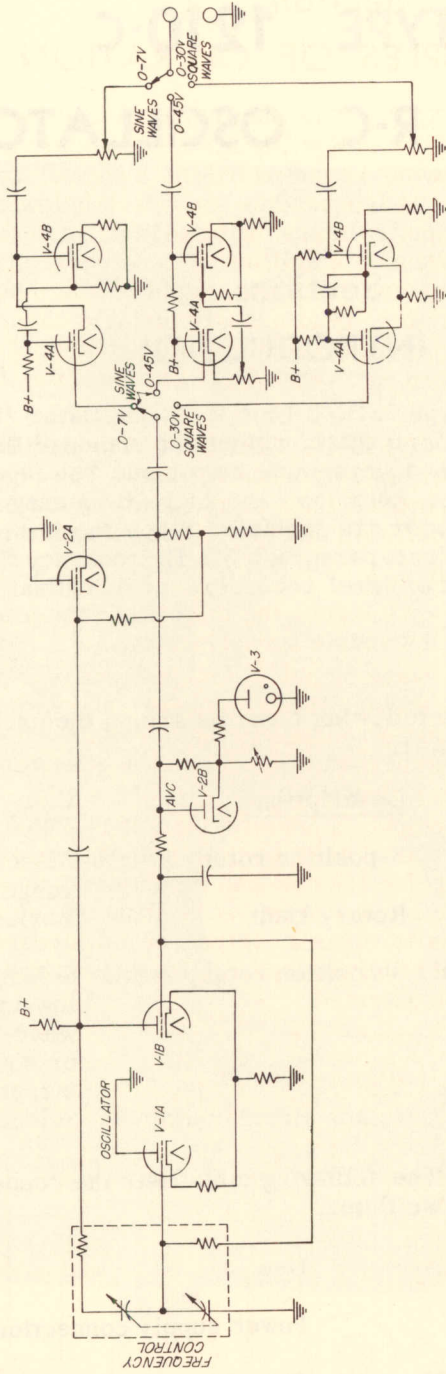

Figure 2. Elementary Schematic Diagram for Type 1210-C Unit R-C Oscillator.

2.1
series
the v
same
quenc
is gr
of at
netwo
at le
deca
stabi

2.2
recti
ence
to re

2.3
2.3.1
ode-
2.3.2
fier
prov
low
crea
2.3.3
yiel
just
R47
C14.
200-
tent

Comp

Section 2

PRINCIPLES OF OPERATION

2.1 OSCILLATOR CIRCUIT. The oscillator circuit is essentially a series-parallel R-C network. (See Figure 2.) At operating frequency, the voltage from the network is one-third the input voltage, and of the same phase as the input. At frequencies above and below operating frequency, the output and input voltages differ in phase and the attenuation is greater than 3 to 1. When an amplifier of zero phase shift and a gain of at least 3 to 1 is connected from the output to the input of the R-C network, the circuit oscillates. Continuously variable capacitors provide at least a 10-to-1 frequency range, and resistor switching provides five decade ranges. Resistors are deposited-carbon-film type for high stability.

2.2 AUTOMATIC GAIN CONTROL CIRCUIT. The oscillator output is rectified and compared with a reference voltage. The resultant difference voltage is filtered and fed back to the grids of the oscillator tube to restrict the level of operation and to yield low distortion.

2.3 OUTPUT AMPLIFIER.

2.3.1 For 0-7-volt sine-wave output, the amplifier uses a modified cathode-follower circuit for low output impedance.

2.3.2 For 0-45-volt sine-wave output, the output tube is a voltage amplifier with degeneration at the oscillator frequency and with a grid leak to provide d-c bias. High output voltage is thus available at satisfactorily low distortion. As the output load is increased, degeneration is also increased and distortion is reduced.

2.3.3 For square-wave output, a Schmitt circuit is used. This circuit yields excellent square waves with a minimum of components and adjustments. Equality of pulse lengths can be obtained by adjustment of R47 (see Figure 3). Overshoot can be set at about 1% by adjustment of C14. Rise time is normally about a third of a microsecond. With a 200-ohm load and a slight readjustment of C14, a rise time of about one-tenth microsecond can be obtained.

Figure 3.
Tube and
Component Layout.

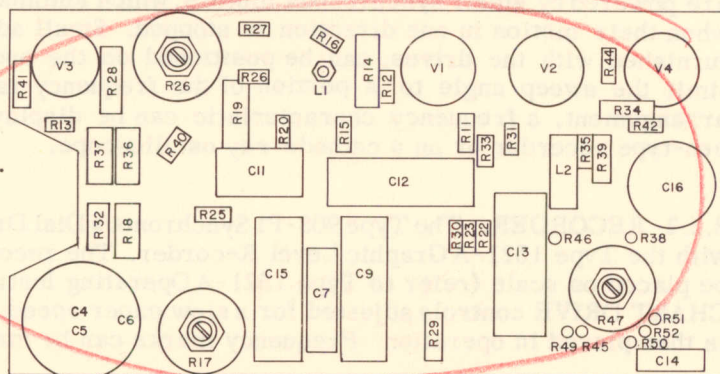

Section 3 INSTALLATION

3.1 POWER SUPPLY.

3.1.1 UNIT POWER SUPPLIES. When plugged into a Type 1203-B Unit Power Supply or Type 1201-B Unit Regulated Power Supply, the Type 1210-C Unit R-C Oscillator is ready for operation from a 115-volt, 50- to 60-cycle power line.

3.1.2 OTHER POWER SUPPLIES. When using a power supply other than a Unit Power Supply, connect the multipoint jack connector (supplied with the Type 1210-C Unit R-C Oscillator) to the power supply. Connections are as follows:

<u>Terminal</u>	<u>To</u>	<u>Terminal</u>	<u>To</u>	<u>Terminal</u>	<u>To</u>
13 and 14	Heaters	15	B+	16	B-

(Terminals 14 and 16 are grounded to the oscillator panel.)

3.1.3 POWER-SUPPLY ATTACHING STRIPS. The Type 1210-C Unit R-C Oscillator can be firmly and permanently attached to any Unit Power Supply by means of the two stainless-steel locking strips supplied with the oscillator. One strip is used at the top, and the other at the bottom. It may be necessary first to remove the dust covers of the instruments and to slide the covers and strips in place simultaneously.

3.2 OTHER ACCESSORY EQUIPMENT.

3.2.1 SWEEP DRIVE. The oscillator dial is gear driven from a knob for high-resolution manual control. The knob and the pinion gear can be replaced by the Types 908-P1 or 907-R144 Dial Drive. These drives are powered by small synchronous motors, which automatically reverse when their motion in one direction is stopped. Small adjustable stops, furnished with the drives, can be positioned on the oscillator dial to limit the sweep angle to a portion of the frequency range. With this arrangement, a frequency characteristic can be displayed either on a pen-type recorder or on a cathode-ray oscilloscope.

3.2.2 RECORDER. The Type 908-P1 Synchronous Dial Drive can be used with the Type 1521-A Graphic Level Recorder. The recorder pen should be placed on scale (refer to Type 1521-A Operating Instructions) and the CHART DRIVE controls adjusted for a slow paper speed. The dial drive is then placed in operation. Frequency marks can be made on the paper

TYPE 1210-C UNIT R-C OSCILLATOR

by means of a momentary-contact switch across the input terminals or by means of the INPUT ATTENUATION control.

3.2.3 PULSE GENERATOR. The Type 1217-A Unit Pulser provides output pulses of excellent quality (0.5 μ sec rise time) at certain discrete frequencies from 30 cycles to 100 kilocycles. When the Unit Pulser is triggered by the Type 1210-C Unit R-C Oscillator, pulses can be obtained at any frequency over the range up to 100 kilocycles. Connect the 0-45-volt output of the oscillator to the EXTERNAL DRIVE terminals of the Unit Pulser (INPUT switch to EXTERNAL TRIGGER). Set the PULSES PER SECOND switch to a rate the same as, or just below, the frequency setting of the Type 1210-C Unit R-C Oscillator.

Section 4

OPERATING PROCEDURE

4.1 FREQUENCY SETTING. The outer scale of the direct-reading four-inch dial is used for the lower four frequency ranges on the FREQUENCY RANGE switch (20-200 c, 200-2000 c, 2-20 kc, and 20-200 kc). The inner scale is used for the 50-500-kc range.

4.2 OUTPUT SYSTEMS.

4.2.1 With the output selector switch set at 0-7 v SINE WAVES, the output terminals are connected to the 5000-ohm output control of a modified cathode-follower circuit. When the output control knob (labeled DECIBELS) is turned fully clockwise, the output impedance is very low (about 50 ohms); the load resistance, however, should not be much less than 500 ohms if excessive distortion is to be avoided. Voltage level is about 7 volts. As the output control knob is turned counterclockwise, the output impedance, which depends on this setting, can be as great as 1250 ohms. When the output control knob is below the -5-db point, the distortion will not be excessive even if the load resistance is less than 500 ohms. For high-impedance loads, the change in output level is given in decibels on the plate at the output control knob. The DECIBELS calibration is sufficiently accurate for use over the entire frequency range. Note that when the output control knob is turned fully clockwise, the arrow points to the end of the circumscribed line (about +5 db) and not to 0. At the full-counterclockwise position the residual output is less than 3 millivolts.

4.2.2 With the output switch set at 0-45 v SINE WAVES, the output terminals are connected through an isolating capacitor to the plate circuit of the amplifier stage. The output control is in the grid circuit. The output impedance of 14 kilohms is thus independent of the setting of the output control, which affects only the voltage level. A 220-kilohm resistor is connected across the output terminals to provide a leakage path for the isolating (electrolytic) capacitor. When the output control knob is at the full-counterclockwise position, the residual voltage is a function of frequency. Typical readings are: less than 0.1 volt from 100 to 20,000 cycles; less than 0.3 volt down to 20 cycles; as much as 1.5 volts at 500 kilocycles. Because of the residual voltage, the DECIBELS calibration of output control is inaccurate for the 0-45-volt range. There is some degeneration in the output stage, and it increases as the load increases. Therefore, loading reduces the distortion.

4.2.3 With the output switch set at the SQUARE WAVES position, the available output is 30 volts peak-to-peak. The rise time is about 1/3

micro
put co
is abo
contro
counte
There
peda
even a

5.1 V
from
will p
of tw
is fo
exam
perso
excep

5.2 S
mater
our s
canno
write
inform
menti

write
Retur
identi
order

5.3
bout
er St

microsecond. The output terminals are connected to the 5000-ohm output control in the plate circuit of the output stage. The output impedance is about 2500 ohms with the control at maximum, and decreases as the control is turned back. The residual voltage, with the control at the full-counterclockwise position, is less than 15 millivolts peak-to-peak. Therefore, if the load impedance is large compared with the output impedance, the DECIBELS calibration of the output control is accurate, even at the lowest settings.

Section 5

SERVICE AND MAINTENANCE

5.1 WARRANTY. We warrant that each new instrument sold by us is free from defects in material and workmanship, and that, properly used, it will perform in full accordance with applicable specifications for a period of two years after original shipment. Any instrument or component that is found within the two-year period not to meet these standards after examination by our factory, district office, or authorized repair agency personnel, will be repaired, or at our option, replaced without charge, except for tubes, or batteries that have given normal service.

5.2 SERVICE. The two-year warranty stated above attests the quality of materials and workmanship in our products. When difficulties do occur, our service engineers will assist in any way possible. If the difficulty cannot be eliminated by use of the following service instructions, please write or phone our Service Department (see rear cover), giving full information of the trouble and of steps taken to remedy it. Be sure to mention the type and serial numbers of the instrument.

Before returning an instrument to General Radio for service, please write to our Service Department or nearest district office, requesting a Returned Material Tag. Use of this tag will ensure proper handling and identification. For instruments not covered by the warranty, a purchase order should be forwarded to avoid unnecessary delay.

5.3 INPUT POWER. The input power at a 115-volt, 60-cycle line is about 35 watts when the oscillator is supplied by a Type 1203-B Unit Power Supply.

TABLE I.
TABLE OF ADJUSTMENTS

PART	CONDITIONS			ADJUST FOR
	FREQUENCY RANGE	DIAL	OUTPUT SWITCH	
R26	200-2000 c	2.5	0-7 v	7.0 v max open-circuit output at 250 cps.
R17	200-2000 c	2.5	0-7 v	Minimum 2d-harmonic distortion at no load.
C3, C10	200-2000 c	20	0-7 v	2000 cps, 7.0 v (measured with dust cover on).
L1	20-200 kc	20	0-7 v	200 kc (measured with dust cover on).
R47	200-2000 c	10	0-30 v	Square-wave symmetry along time axis.
C14	200-2000 c	10	0-30 v	Slight overshoot (square wave) - less than 1%.

5.4 R
screw

5.5 T

5.5.1
is repl
for 7.0
proced
tortion

5.5.2
freque
range
justm

5.5.3
tion a

5.5.4
adjust
C14 m

5.5.5
styren
ground
terial

5.6 T
page
tube-s
values

TYPE 1210-C UNIT R-C OSCILLATOR

5.4 REMOVAL OF COVER. To remove the cover, loosen the thumb-screw on the right-hand side of the cabinet.

5.5 TUBE REPLACEMENT AND ADJUSTMENTS. (Refer to Table 1.)

5.5.1 If either the oscillator tube (V1) or the reference-voltage tube (V3) is replaced, the only readjustment usually required is the resetting of R26 for 7.0 volts maximum open-circuit output at 250 cps. A more complete procedure when V1 is replaced involves setting R17 for minimum distortion while maintaining the output at 7.0 volts by means of R26.

5.5.2 The trimmer capacitors (C3 and C10) have been set for correct frequency tracking and for flatness of output over the 200-2000-cycle range, with the cover on. Replacement of V1 may require a slight readjustment of C10.

5.5.3 The dust core of L1 has been set for correct frequency calibration at 200 kilocycles (20-200-kilocycle range) with the cover on.

5.5.4 If the output amplifier tube (V4) is replaced, R47 may require readjustment for equality of pulses during square-wave operation. Also, C14 may require resetting to keep overshoot to less than one percent.

5.5.5 The hub of the frequency dial is insulated from the shaft by a polystyrene sleeve, and is grounded to the panel by spring washers. If this ground is incorrectly made, the 60-cycle beat (0-7-volt range) may materially exceed a swing of 0.3 volt.

5.6 TUBE VOLTAGE AND RESISTANCE MEASUREMENTS. Table 2, page 10, gives the normal d-c voltage and d-c resistance from various tube-socket pins to ground. A deviation of 20 percent from any of these values is not necessarily abnormal.

TABLE 2
VOLTAGE AND RESISTANCE CHART

TUBE	OUTPUT SWITCH POSITION			PLATE			GRID			CATHODE		
	PIN	VOLTS TO GND	RES TO GND	PIN	VOLTS TO GND	RES TO GND	PIN	VOLTS TO GND	RES TO GND	PIN	VOLTS TO GND	RES TO GND
V1	1	+215	7kΩ	2	42.5 - 46.5	1.5 - 14 MΩ*	3	48	3kΩ	3	48	3kΩ
V1 6189	6	160	1.2kΩ	7	42	1.5 MΩ	8	45.5	2700Ω	8	45.5	2700Ω
V2	1	295	1kΩ	2	114	0.3-1 MΩ*	3	120	23kΩ	3	120	23kΩ
V2 (12AU7)	6	40	700kΩ	7	40	0.7 MΩ	8	49	15kΩ	8	49	15kΩ
V3 (6B2)	1,5	165	10.5kΩ				7	59	8.2kΩ			
V4	1	290	1.8kΩ	2	148	0.5 MΩ	3	150	∞	3	150	∞
V4	6	150	∞	7	0	57 kΩ	8	1.5	120Ω	8	1.5	120Ω
V4	1	295	1.8kΩ	2	26	90 kΩ	3	31	5kΩ	3	31	5kΩ
V4	6	90-140†	23kΩ	7	7-12†	57.5 kΩ	8	9.5-12†	1.5kΩ	8	9.5-12†	1.5kΩ
V4	1	240	5.7kΩ	2	86	270 kΩ	3	93	6.8kΩ	3	93	6.8kΩ
V4 (6BQ7-A)	6	265	6.1kΩ	7	80	39 kΩ	8	93	6.8kΩ	8	93	6.8kΩ

NOTES

- (1) Input resistance of d-c voltmeter must be at least ten times the value listed in the resistance column.
- (2) * - Depends on position of FREQUENCY RANGE switch.
- (3) † - Depends on position of output control knob.
- (4) Voltage measurements were made with a B supply switch.
- (5) Resistance measurements were made with the power supply removed and with the B supply terminals shorted (PL-1 No. 15 to ground).

Figure 4. Schematic Diagram for Type 1210-C Unit R-C Oscillator.

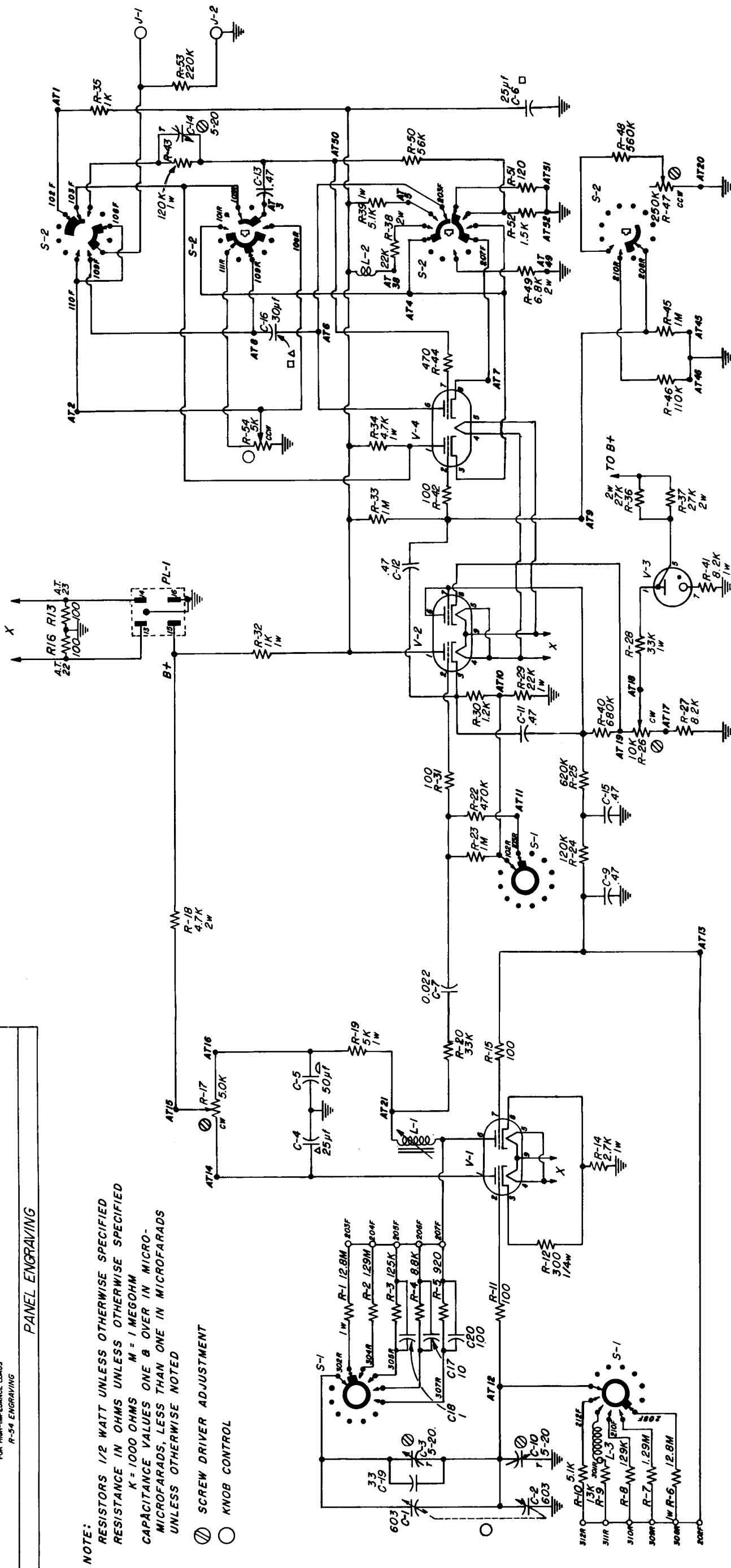

NOTE:
 RESISTORS 1/2 WATT UNLESS OTHERWISE SPECIFIED
 RESISTANCE IN OHMS UNLESS OTHERWISE SPECIFIED
 $K = 1000$ OHMS $M = 1$ MEGOHM
 CAPACITANCE VALUES ONE & OVER IN MICRO-
 MICROFARADS, LESS THAN ONE IN MICROFARADS
 UNLESS OTHERWISE NOTED

⊕ SCREW DRIVER ADJUSTMENT
 ○ KNOB CONTROL

PANEL ENGRAVING

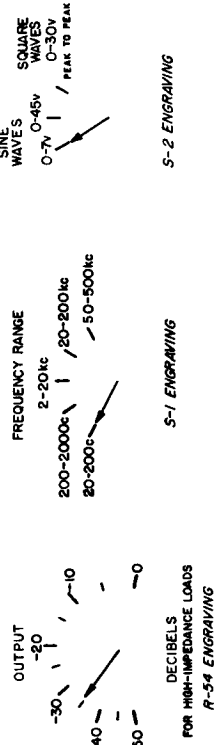

PARTS LIST

				PART NO. (NOTE A)					PART NO. (NOTE A)	
RESISTORS (NOTE B)	R1	12.8M	± 1%	1 w	REF-75	R46	110k	± 5%	1/2w	REC-20BF
	R2	1.29M	± 1%	1 w	REF-70	R47	250k	±10%		POSC-11
	R3	125.0k	± 1%	1/2w	REF-70	R48	560k	± 5%	1/2w	REC-20BF
	R4	8.8k	± 1%	1/2w	REF-70	R49	6.8k	± 5%	2 w	REC-41BF
	R5	920	± 1%	1/2w	REF-70	R50	56k	± 5%	1/2w	REC-20BF
	R6	12.8M	± 1%	1 w	REF-75	R51	120	± 5%	1/2w	REC-20BF
	R7	1.29M	± 1%	1 w	REF-70	R52	1.5k	± 5%	1/2w	REC-20BF
	R8	129k	± 1%	1/2w	REF-70	R53	220k	± 5%	1/2w	REC-20BF
	R9	13k	± 1%	1/2w	REF-70	R54	5k	±10%		POSC-12
	R10	5.1k	± 1%	1/2w	REF-70	CAPACITORS (NOTE C)				
	R11	100	± 5%	1/2w	REC-20BF					
	R12	300	± 1%	1/4w	REF-65					
	R13	100	± 5%	1/2w	REC-20BF					
	R14	2.7k	± 1%	1 w	REF-75					
	R15	100	± 5%	1/2w	REC-20BF					
	R16	100	± 5%	1/2w	REC-20BF					
	R17	5.0k	±10%		POSW-3					
	R18	4.7k	±10%	2 w	REC-41BF					
	R19	5k	± 1%	1 w	REF-75					
	R20	33k	± 5%	1/2w	REC-20BF					
	R21									
	R22	470k	± 5%	1/2w	REC-20BF					
	R23	1M	± 5%	1/2w	REC-20BF					
	R24	120k	± 5%	1/2w	REC-20BF					
	R25	620k	± 5%	1/2w	REC-20BF					
	R26	10k	±10%		POSW-3					
	R27	8.2k	± 5%	1/2w	REC-20BF					
	R28	33k	± 1%	1 w	REF-75					
	R29	22k	± 5%	1 w	REC-30BF					
	R30	1.2k	± 5%	1/2w	REC-20BF					
	R31	100	± 5%	1/2w	REC-20BF					
	R32	1k	±10%	1 w	REC-30BF					
	R33	1M	± 5%	1/2w	REC-20BF					
	R34	4.7k	± 5%	1 w	REC-30BF					
	R35	1k	± 5%	1/2w	REC-20BF					
	R36	27k	±10%	2 w	REC-41BF					
	R37	27k	±10%	2 w	REC-41BF					
	R38	22k	±10%	2 w	REC-41BF					
	R39	5.1k	± 5%	1 w	REC-30BF					
	R40	680k	± 5%	1/2w	REC-20BF					
	R41	8.2k	± 5%	1 w	REC-30BF					
	R42	100	± 5%	1/2w	REC-20BF					
	R43	120k	± 5%	1 w	REC-30BF					
	R44	470	± 5%	1/2w	REC-20BF					
	R45	1M	± 5%	1/2w	REC-20BF					
					C1	603 μf			1210-400	
					C2	603 μf				
					C3	5-20 μf			COT-18	
					C4	25	450 dcwv		COE-10	
					C5	50				
					C6	25				
					C7	0.022 ±10%	600 dcwv		COL-71	
					C8					
					C9	0.47 ±10%	200 dcwv		COW-27	
					C10	5-20 μf			COT-18	
					C11	0.47 ±10%	200 dcwv		COW-16	
					C12	0.47 ±10%	200 dcwv		COW-27	
					C13	0.47 ±10%	400 dcwv		COW-25	
					C14	5-20 μf			COT-18	
					C15	0.47 ±10%	200 dcwv		COW-27	
					C16	30	350 dcwv		COE-53	
					C17	10μf ±10%	500 dcwv		COC-21 NPO	
					C18	1.0μf ±10%	500 dcwv		COC-1	
					C19	33 μf ±10%	500 dcwv		COC-21 N750	
					C20	100μf ±10%	500 dcwv		COC-21 Max neg.	
					L1	INDUCTOR, 500-1000 μh			1210-41	
					L2	INDUCTOR, 5 mh (approx)			CHA-3-5	
					L3	INDUCTOR, 500 μh			CHA-597A	
					S1	SWITCH, Rotary			SWRW-150	
					S2	SWITCH, Rotary			SWRW-151	
					V1	TUBE			6189/12AU7WA	
					V2	TUBE			12AU7	
					V3	TUBE			OB2	
					V4	TUBE			6BQ7A	

NOTES

(A) Type designations for resistors and capacitors are as follows:

COC - Capacitor, ceramic
 COE - Capacitor, electrolytic
 COL - Capacitor, oil
 COM - Capacitor, mica
 COT - Capacitor, trimmer

COW - Capacitor, wax
 POSC - Potentiometer, composition
 POSW - Potentiometer, wire-wound
 REC - Resistor, composition
 REF - Resistor, film

(B) All resistances are in ohms, except as otherwise indicated by k (kilohms) or M (megohms).

(C) All capacitances are in microfarads, except as otherwise indicated by μf (micromicrofarads).

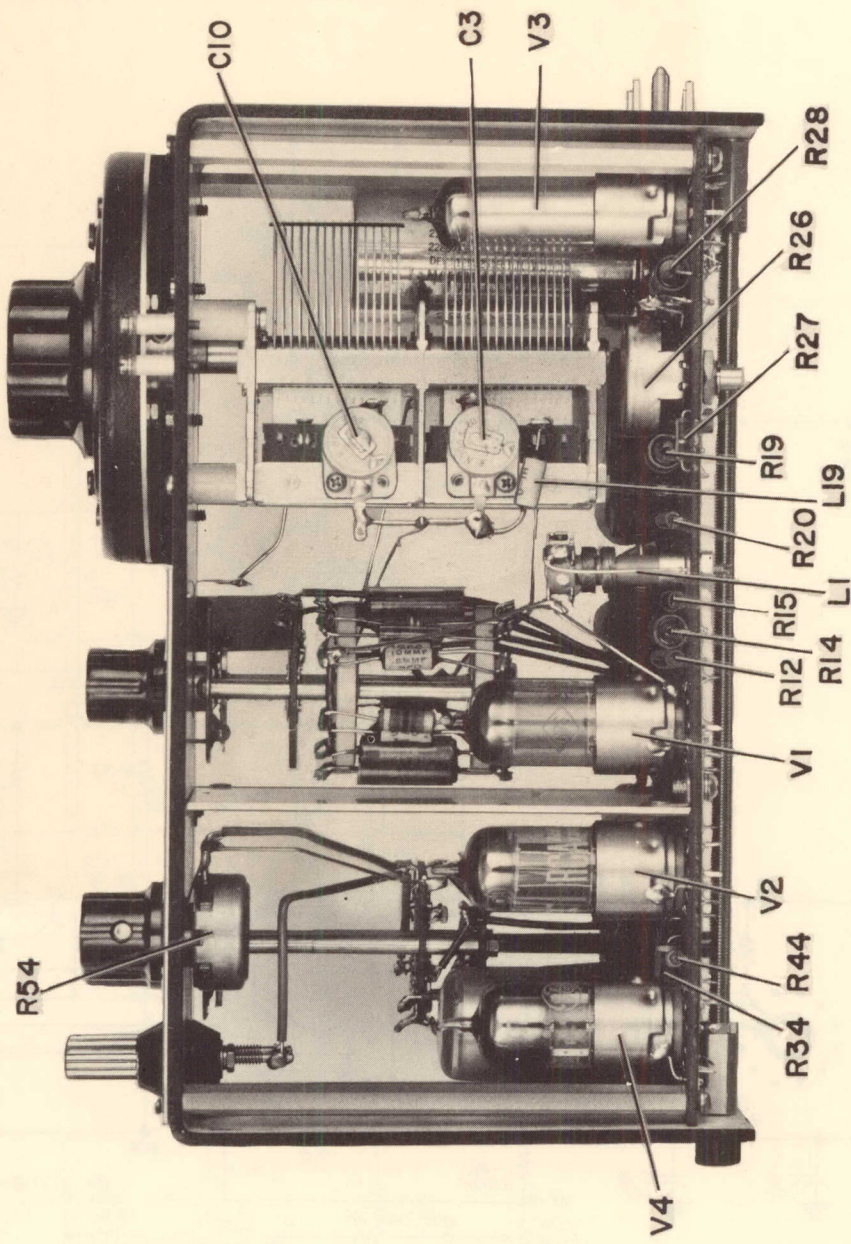
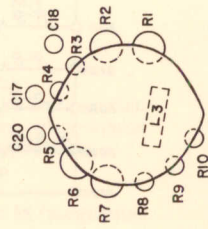
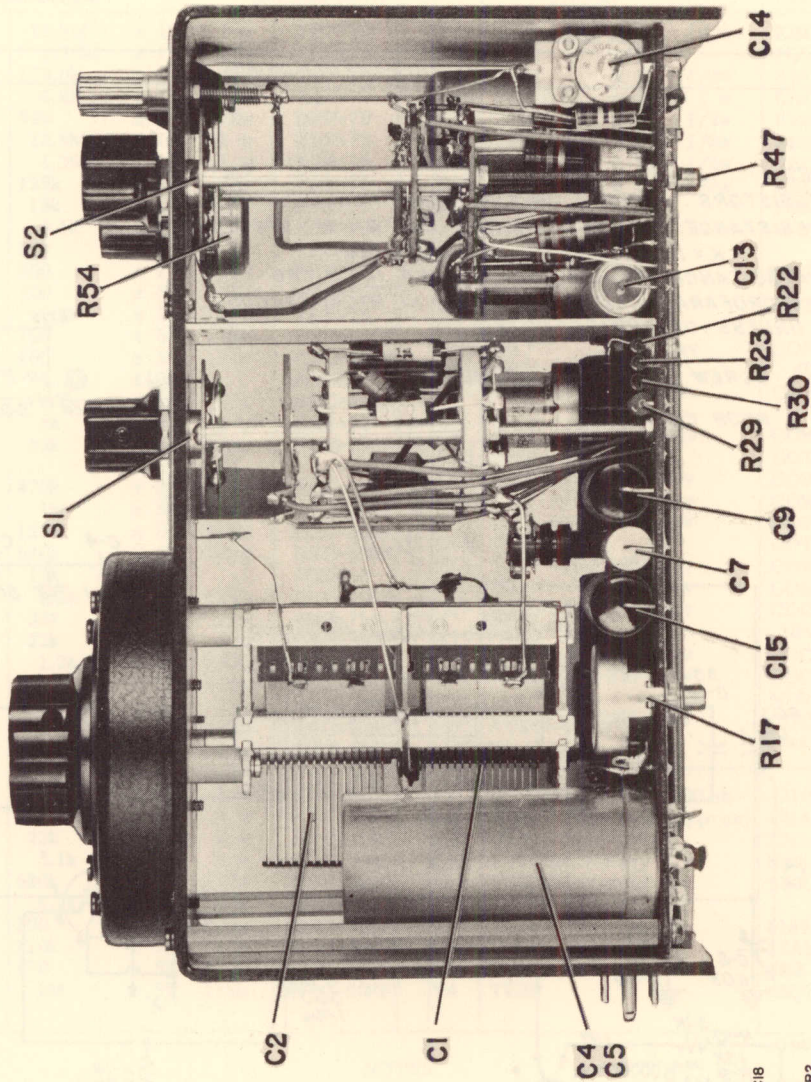

Figure 5. Top Interior View of Type 1210-C Unit R-C Oscillator.



COMPONENTS MOUNTED ON S1
(VIEWED FROM REAR)

Figure 6. Bottom Interior View of Type 1210-C Unit R-C Oscillator.